



Redundant, clean, sine-wave AC power ensures a high availability of mission-critical safety devices, instrumentation, alarms, controls and computers. Robust, StatiVolt UPS Systems are designed and built for decades of industrial duty and field serviceability. Since 1964, time-proven applications to industrial loads are testimony to their reliability.

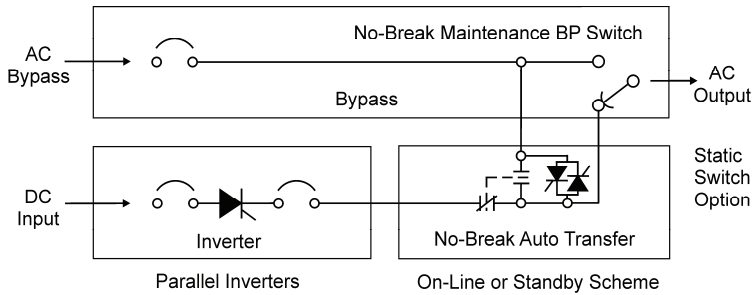

Table with columns: Output kVA (1Ø, 3Ø), DC Input kW (24 V, 48 V, 125 V, 250 V). Rows list various power ratings from 0.6 to 60.0 kVA.

Features

Reliability by Design

- Pure sine-wave AC power
• Low frequency, soft-switching
• Natural convection cooled
• 30 year design life

Low DC Input Voltage

- 24, 48, 125, 250 V DC nominal
• Battery-only start-up capability

Protection

- In, out, bypass circuit breakers
• Fail-safe output current limiting
• Transformer isolation
• Fail-safe output V control
• Inherent surge rejection
• Inherent AC fault limiting

Versatile Functions & Options

- DC Input Low V Shutdown
• Dual AC Output Voltages
• Static Switch initiated transfer
• Bypass Transformer
• Special Utility Options

Warranty & Service

- 2 year full, 5 year major parts
• Fully field serviceable
• 20 year parts availability

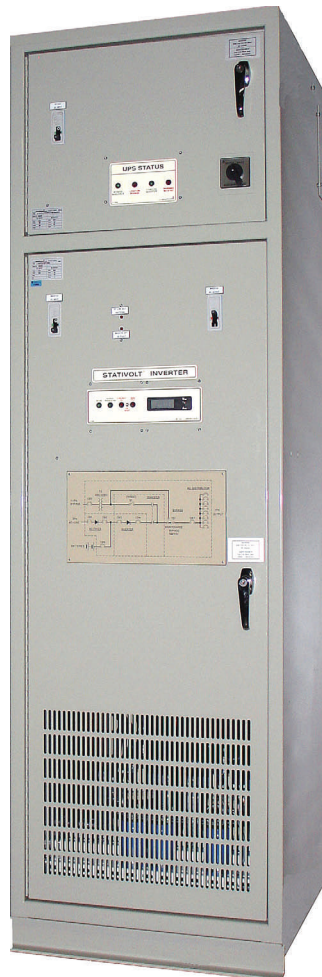

Contents

Table listing contents: Inverter Specifications (2), Transfer Specifications (3), 1Ø System Cabinets (4), 3Ø System Cabinets (5, 6), Model Numbers, Options (7)





### Inverter Specs

#### Power Conversion Design

- SCR chopper, commutation transformer
- Tuned ferro-resonant output
- Pure sine-wave AC power
- Rated for load Crest Factors  $\leq 3.0$

#### Output Control

- Fail-safe, closed-loop control
- High speed electronic V sensing
- Magnetic shunt regulation
- True oscillator output frequency

#### Steady-State Full Load V & F Regulation

- $\pm 1\%$  (-16% to +15% of nominal DC V)
- $\pm 0.10$  Hz frequency, 1 Hz / s slew rate

#### Overload Capacity

- 125% 30 min, 150% 10 min, 200% 60 s

#### Annunciation & Meters

- Standard annunciation (each phase):  
V+A AC Meter digital, 1% accuracy  
AC On green LED  
Normal Reg. green LED  
Low V O/L red LED, contacts  
High V red LED  
DC Low V red LED, contacts  
Inv. Off / Fault red LED, contacts
- Contacts are form 'C' contacts rated:  
3 A (120 V<sub>AC</sub> & 30 V<sub>DC</sub>), 0.3 A (125 V<sub>DC</sub>)

#### Full Load Efficiency (%)

kVA		Nominal DC Voltage			
1Ø	3Ø	24	48	125	250
0.6	1.8	62	63	65	68
1.2	3.6	69	70	73	78
2	6	73	76	80	84
3	9	74	78	82	86
4	12	75	79	83	88
5	15	75	80	84	89
6-15	18-45		80	85	90
20-60	60-180			85	90

#### Protection

- DC breaker rated  $I \approx 1.5 \times$  full load I<sub>DC</sub>
- AC breaker rated  $I \approx 1.25 \times$  full load I<sub>AC</sub>
- Transformer electrical isolation
- I<sup>2</sup>t breaker coordinated SCRs & diodes
- I limiting set to start at 125% of full load

#### DC Input Reflected Ripple Voltage

- $\leq 1\%$  rms (without battery)
- $\leq 0.5\%$  rms (on typical battery)
- Noise filter option ( $< 32$  dBnC noise)

#### Startup DC Inrush Current

- $\leq 1.5 \times$  full load input Amps for  $< 30$  ms

#### Output AC V Range

- $\pm 10\%$  of nominal ( $\pm 5\%$  regulator adjust,  $\pm 5\%$  transformer tap adjust)

#### Dynamic AC V Response

- $\pm 5\%$  for 50% resistive step-loads
- $\pm 10\%$  for 100% resistive step-loads
- Recovery  $< 17$  ms (50% step-load)

#### Parallel Inverter Operation

- Load sharing within 10% of unit I<sub>AC</sub>

#### Audible Noise

- 55-65 dBA (at 1 m, rating dependent)

#### Output Distortion & Noise

- THD is  $< 5\%$  (p-n) and  $< 3\%$  (p-p)
- 0.1 to 30 MHz wide-band filter
- 120 dB common mode noise rejection
- 60 dB transverse mode attenuation

#### Surge Tolerance

- Inherent I / O surge protection
- Withstands ANSI / IEEE C62.41 (IEC 6080-4) standard surge V waveforms

#### Electromagnetic Interference

- Conducted / radiated EMI within CSA C108.8 & FCC Part 15 Class B limits

#### Wiring

- Stranded 16 AWG control wires
- Plastic sleeve-type wire markers
- Wire ( $\leq 10$  AWG) connection ferrules

#### Cabinets

- NEMA type 1
- Front accessible, side / top cable entry
- 14 / 10 gage steel panels / mounts
- Powder-coated, baked enamel finishes

#### Environmental Requirements

- Natural convection cooled: top, side, rear clearances required for air flow.
- $-20^\circ\text{C}$  to  $+40^\circ\text{C}$  continuous operation
- RH  $< 95\%$  non-condensing

#### Reliability

- MTBF is 120 k hrs (1Ø), 40 k hrs (3Ø)
- MTTR is 1 hour (spares on / near site)

#### Design & Test Standards

- CSA certified (C22.2 No. 107.1-01)
- Generally per NEMA, ANSI, IEEE, IEC
- Magnetics operate at max. 125°C
- Magnetics designed for Class 220°C

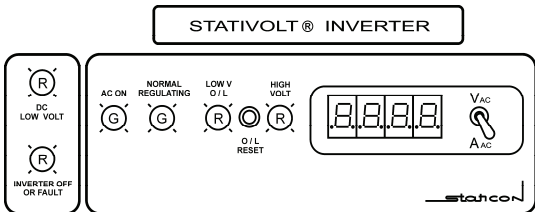

#### Single-Line Diagram With Controls

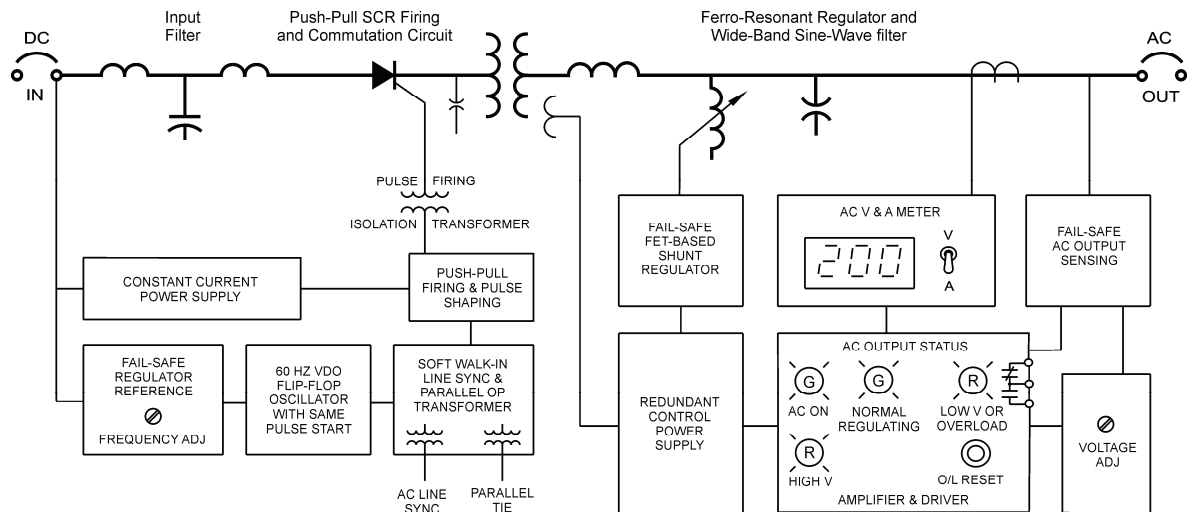

Oscillator Module

AC Voltage Regulator & Status Module





### On-Line Transfer Specs

#### System Operation

- Normal power via inverter(s) (on-line)
- DC / inverter failure initiates a no-break (< ¼ cycle) transfer to bypass power
- Transfer is via a line redundant transfer logic (LRTL) and a contactor
- Optional static switch + contactor

#### Transfer to Bypass

- LRTL senses AC voltage, transfers @ 75% of nominal AC V (60-100% adj.)
- LRTL initiates transfer by energizing contactor coil (bypass powered)
- Ferro-resonant stored energy enhances no-break operation
- Inverter and bypass frequencies are synchronized within a 1 Hz range
- Auto (60 s delay) or optional manual no-break retransfer of load to inverter

#### Protection

- DC sensing fuse
- Bypass brkr rated  $I \approx 1.5 \times \text{full load } I_{AC}$

#### Reliability

- MTBF is 560 k hrs
- MTTR is 1 hour (spares on / near site)

#### Annunciation & Meters

- Standard annunciation:

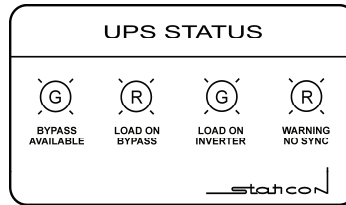

Inv / Bypass Status dry contacts  
 AC V Meter digital 1% acc.  
 AC A Meter (1Ø) digital 1% acc.

- Contacts are form 'C' contacts rated: 3 A (120 V<sub>AC</sub> & 30 V<sub>DC</sub>), 0.3 A (125 V<sub>DC</sub>)
- Optional annunciation & meters  
 Differential frequency sensor to monitor bypass frequency  
 AC F Meter analog 2% acc.

#### Design & Test Standards

- CSA certified (C22.2 No. 107.1-01)
- Generally per NEMA, ANSI, IEEE, IEC

### Maintenance Bypass

#### Maintenance Bypass (BP)

- Make-before-break (< ¼ cycle) manually operated rotary cam switch
- Transfers load to the bypass line
- Isolates inverter system for maintenance / repair purposes

#### Manual System Isolation

- Open inverter I / O breakers
- Switch load to maintenance bypass via the maintenance bypass switch
- Disconnect DC sensing fuse
- Open AC sensing isolation switch
- Contactor is de-energized

#### Manual System Return to Inverter

- Post-service no-break retransfer
- Reconnect DC sensing fuse
- Close AC sensing isolation switch
- Close inverter input breaker, then output breaker
- Return maintenance bypass switch to the inverter position
- Inverter power restored (60 s delay)

### Standby Transfer Specs

#### System Operation

- Normal power via AC bypass (BP)
- AC failure initiates a no-break (< ¼ cycle) transfer to inverter power
- Transfer is via a standby transfer logic (SBTL) and a contactor
- Optional static switch + contactor

#### Transfer to Bypass

- SBTL senses AC voltage, transfers @ 75% of nominal AC V (60-100% adj.)
- SBTL initiates transfer by energizing contactor coil (inverter powered)
- Ferro-resonant stored energy enhances no-break operation
- Inverter and bypass frequencies are synchronized within a 1 Hz range
- Auto (60 s delay) or optional manual no-break retransfer of load to AC BP

#### Protection

- DC sensing fuse
- Bypass brkr rated  $I \approx 1.5 \times \text{full load } I_{AC}$

#### Reliability

- MTBF is 560 k hrs
- MTTR is 1 hour (spares on / near site)

#### Annunciation & Meters

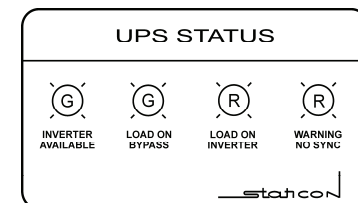

- Standard annunciation:

Inv / Bypass Status dry contacts  
 AC V Meter digital 1% acc.  
 AC A Meter (1Ø) digital 1% acc.

- Contacts are form 'C' contacts rated: 3 A (120 V<sub>AC</sub> & 30 V<sub>DC</sub>), 0.3 A (125 V<sub>DC</sub>)
- Optional annunciation & meters  
 Differential frequency sensor to monitor bypass frequency  
 AC F Meter analog 2% acc.

### Transfer Cabinets

#### Cabinets

- Integrated with inverter UPS
- NEMA type 1
- Front accessible, side / top cable entry
- 14 / 10 gage steel panels / mounts
- Powder coated, baked enamel finishes

#### Environmental Requirements

- Natural convection cooled, top, side, rear clearances required for air flow.
- -20°C to +40°C continuous operation
- RH < 95% non-condensing





### 1Ø System Standard Cabinets

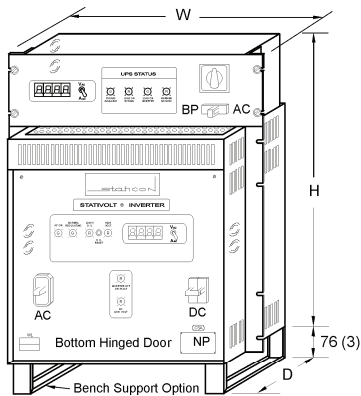

Rack Mount Cabinet (R)

#### Dual Redundant Systems

Parallel, floor mount, inverter systems (2 parallel inverters combined with one transfer) are 2x the width and weight as shown in the table.

#### Bypass Transformer

The optional bypass transformer is housed in the transfer section of any inverter UPS.

#### Construction

EEMAC / NEMA type 1 cabinets. Front access. 14 / 10 gage steel panels / mounting channels. Standard finish is ASA 61 grey, baked enamel.

Side cable entry for rack mount cabinets.  
Top cable entry for floor mount cabinets.

#### Required Ventilation Clearance:

Rack Cabs: 89 (3.5) space all sides.  
Floor Cabs: 305/610 (12/24) rear/top space.

Output kVA	Cabinet Style	Dimensions mm (in)			Weight kg (lb)
		H	W	D	
0.6	R	445 (17.5)	584 (23)	508 (20)	45 (99)
1.2	R	579 (22.8)	584 (23)	508 (20)	65 (143)
2	R	668 (26.3)	584 (23)	508 (20)	80 (176)
3	R	757 (29.8)	584 (23)	508 (20)	105 (231)
4	F1	1905 (75)	610 (24)	610 (24)	200 (441)
5	F1	1905 (75)	610 (24)	610 (24)	240 (529)
6	F1	1905 (75)	610 (24)	610 (24)	280 (617)
7.5	F1	2057 (81)	610 (24)	610 (24)	310 (683)
10	F1	2057 (81)	610 (24)	762 (30)	350 (772)
12.5	F1	2057 (81)	610 (24)	762 (30)	400 (882)
15	F1	2210 (87)	610 (24)	762 (30)	480 (1058)
20	F1	2210 (87)	762 (30)	762 (30)	670 (1477)
25	F1	2210 (87)	762 (30)	762 (30)	840 (1852)
30	F2	2210 (87)	1372 (54)	914 (36)	1150 (2921)
40	F2	2210 (87)	1372 (54)	914 (36)	1280 (2821)
50	F2	2210 (87)	1676 (66)	914 (36)	1550(3937)
60	F2	2210 (87)	1676 (66)	914 (36)	1850 (4079)

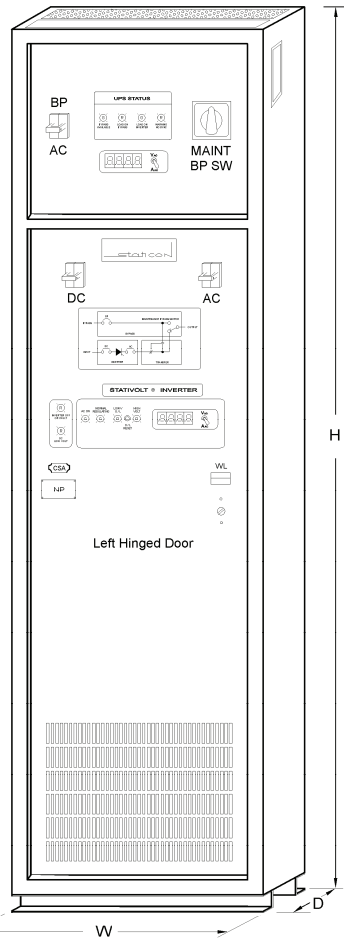

Floor Mount Cabinet (F1)

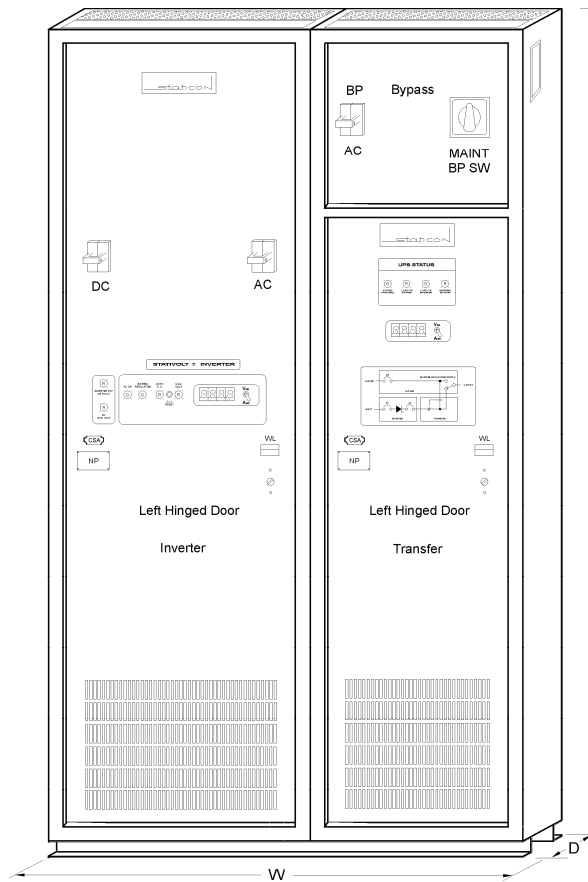

Floor Mount Cabinet (F2)

#### Notes

Actual systems may vary from these cabinet standards according to job-specific options or custom requirements.

All dimensions in mm (inches).  
Drawings are not to scale.

#### Anchoring Detail

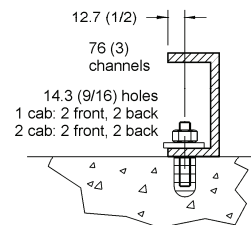



3Ø System Standard Cabinets

Output kVA	Cabinet Style	Dimensions mm (in)			Weight kg (lb)
		H	W	D	
1.8	F1	2057 (81)	610 (24)	610 (24)	225 (496)
3.6	F1	2057 (81)	610 (24)	610 (24)	250 (551)
6	F1	2210 (87)	610 (24)	762 (30)	300 (661)
9	F1	2210 (87)	610 (24)	762 (30)	450 (992)
12	F3	2057 (81)	1829 (72)	610 (24)	650 (1433)
15	F3	2057 (81)	1829 (72)	610 (24)	790 (1742)
18	F3	2057 (81)	1829 (72)	610 (24)	925 (2040)
22.5	F3	2057 (81)	1829 (72)	610 (24)	1030 (2271)
30	F3	2057 (81)	1829 (72)	762 (30)	1150 (2535)
37.5	F3	2057 (81)	1829 (72)	762 (30)	1380 (3043)
45	F3	2210 (87)	1829 (72)	762 (30)	1630 (3594)
60	F3	2210 (87)	2286 (90)	762 (30)	2110 (4652)

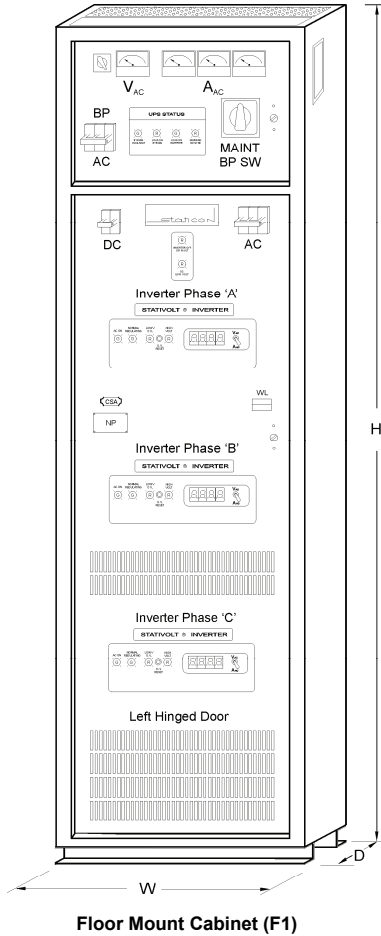

**Dual Redundant Systems**

Parallel, floor mount, inverter systems (2 parallel inverters combined with one transfer) are 2x the width and weight as shown in the table.

**Bypass Transformer**

The optional bypass transformer is housed in the transfer section of any inverter UPS.

**Construction**

EEMAC / NEMA type 1 cabinets. Front access. 14 / 10 gage steel panels / mounting channels. Standard finish is ASA 61 grey, baked enamel.

Top cable entry for floor mount cabinets.

Required Ventilation Clearance:

Floor Cabs: 305/610 (12/24) rear/top space.

**Notes**

Actual systems may vary from these cabinet standards according to job-specific options or custom requirements.

All dimensions in mm (inches). Drawings are not to scale.

**Anchoring Detail**

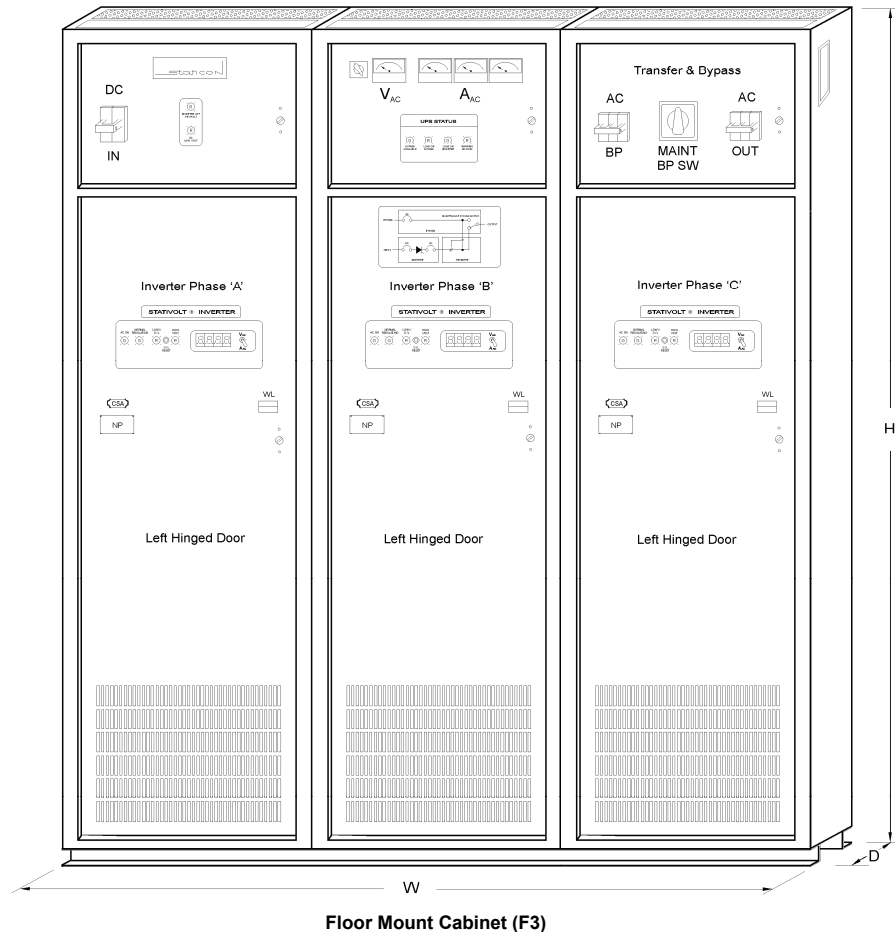
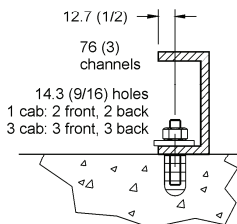



### 3Ø System Standard Cabinets

Output kVA	Cabinet Style	Dimensions mm (in)			Weight kg (lb)
		H	W	D	
75	F4	2210 (87)	2896 (114)	762 (30)	2010 (4431)
90	F4	2210 (87)	2896 (114)	762 (30)	2350 (5181)
120	F4	2210 (87)	3048 (120)	762 (30)	2850 (7239)
150	F4	2210 (87)	3505 (138)	914 (36)	3280 (7231)
180	F4	2210 (87)	3962 (156)	914 (36)	3800 (8378)

#### Dual Redundant Systems

Parallel, floor mount, inverter systems (2 parallel inverters combined with one transfer) are 2x the width and weight as shown in the table.

#### Bypass Transformer

The optional bypass transformer is housed in the transfer section of any inverter UPS.

#### Construction

EEMAC / NEMA type 1 cabinets. Front access. 14 / 10 gage steel panels / mounting channels. Standard finish is ASA 61 grey, baked enamel.

#### Notes

Actual systems may vary from these cabinet standards according to job-specific options or custom requirements.

All dimensions in mm (inches). Drawings are not to scale.

Top cable entry for floor mount cabinets.

Required Ventilation Clearance:

Floor Cabs: 305/610 (12/24) rear / top space.

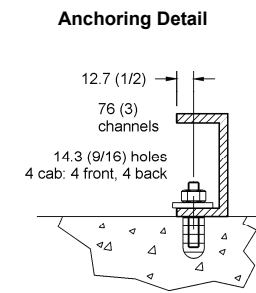
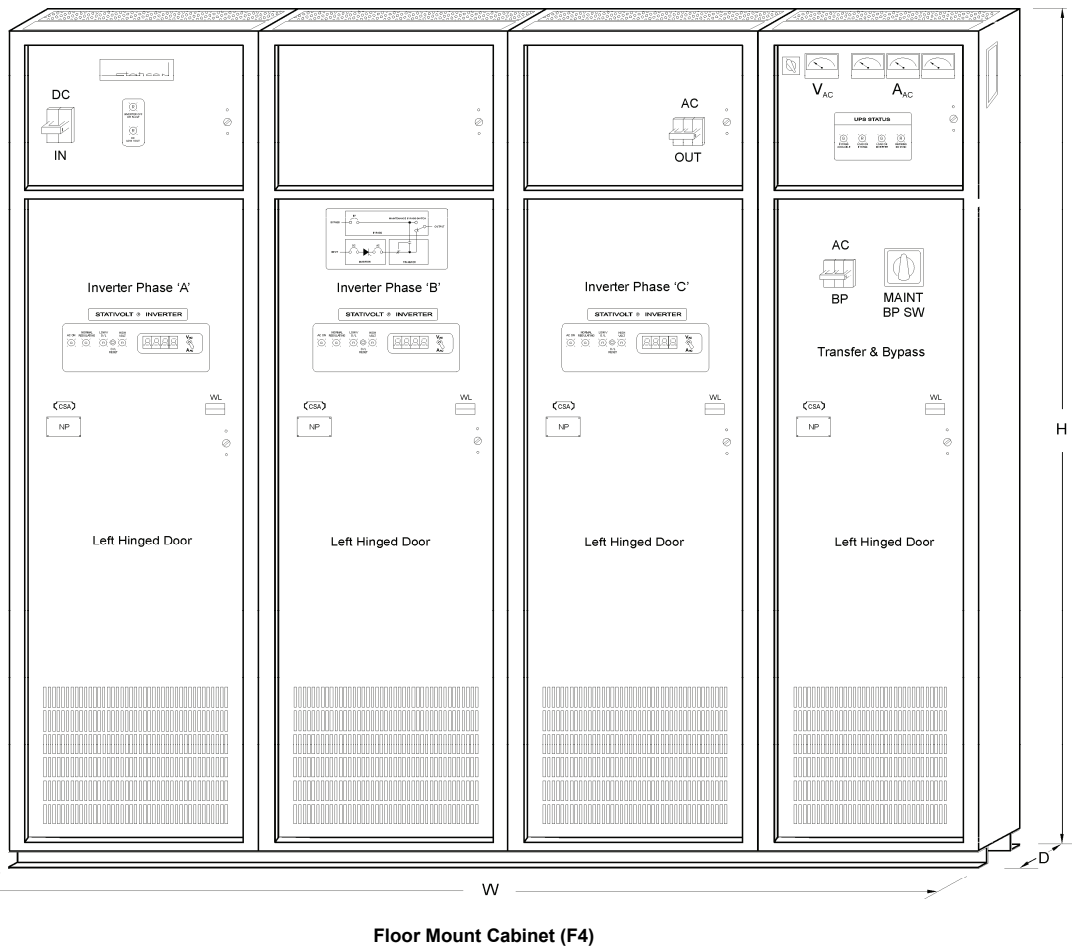



Model Numbers

_ AC 6 A LA 48 206 F 125 B M _										AC V Code	Ø	60Hz	50Hz	
										L Options Codes (see below)	110-120-127	1	A	
										L (M)aintenance BP Switch	208-240	1	B	
										L (B)attery Ripple Filter	120-208-240	1	T	BX
										L DC Nominal Voltage	220-230-240	1	U	UX
										L (R)ack or (F)loor mount	480	1	G	
										L Height (cm)	600	1	H	
										L Width (cm)	208-220 Y	3	EY	EXY
										L On-Line (LA)uto or (LM)anual, or Standby (SB) Transfer	380-400-415 Y 3	3	LY	LXY
										L AC Output Voltage Code (see table at right)	480 Y	3	FY	
										L Inverter System kVA rating	600 Y	3	KY	
L For ≥ 2 parallel inverters add # prefix														

Options

Options	DC Input Options	Code
	Input ripple filter, AC ripple ≤ 1% rms (standard)	B
	Input telecom noise filter, noise ≤ 32 dBmC (24 & 48 V DC only)	C
	DC low V shutdown, nominal to -17% DC input voltage range, adjustable	Ls
	DC Ground leakage alarm, 2 red LEDs, 1 set of form 'C' contacts, 1-5 mA adjustable	G
	Digital DC V & A meter, 1% accuracy, switch selectable	Dm
	<b>AC Output Options</b>	
	50 Hz output voltage frequency	see AC V code
	Dual AC output voltage, 120 / 240 VAC (120-N-120)	Do
	<b>Transfer / Bypass Options</b>	
	Staticon no-break, energy storage & contactor based auto transfer	standard
	Static switch + contactor based, ≤ ¼ cycle break auto transfer	S
	On-line (line redundant) auto return transfer (60 s delay)	LA
	On-line (line redundant) manual return transfer	LM
	Off-line (standby) auto return transfer (60 s delay)	SA
	Off-line (standby) manual return transfer	SM
	Maintenance bypass switch, manual make-before-break rotary cam switch (standard)	M
	Bypass step-down / isolation transformer	X
	<b>Annunciation Options</b>	
	Frequency meter, analog, 2% accuracy	F
	Differential frequency sensor to monitor bypass power frequency	Fd
	Common system failure alarm, 1 extra set of form 'C' contacts	Ca
	Audible system failure alarm	A
	<b>Utility Options</b>	
	Keyed door locks with handles	K
	High interrupting-ampere capacity input / output / bypass breakers (consult Staticon)	I
	I / O breaker visible contacts and lock attachments	V
	Auxiliary contacts for any single input, output, bypass or distribution breaker	Ac
	Zinc Rich powder coat paint primer for enhanced corrosion protection	Z
	White interior paint	W
	<b>Packaging Options</b>	
	Tropical / humidity proofing, acrylic sprayed components and wires	T
	Export packaging per international ocean freight requirements	

